

B1NF360V-QR20-IOLX3-H1141

Dynamic Inclinometer

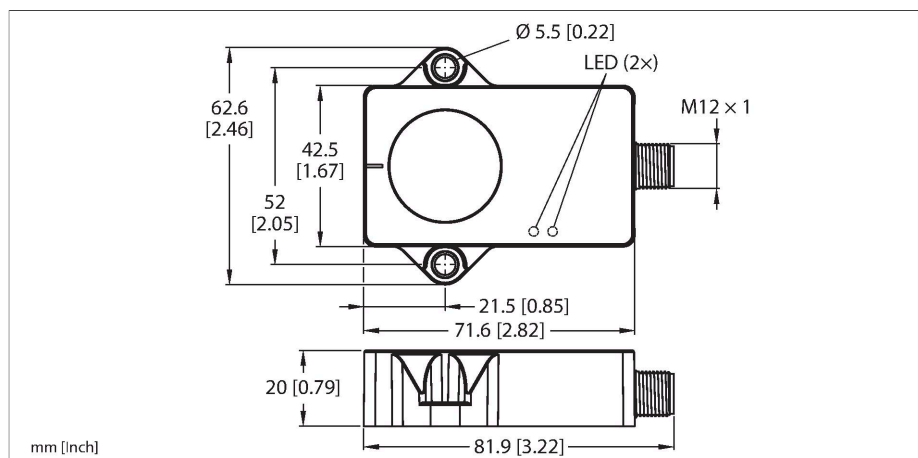

Technical data

Type	B1NF360V-QR20-IOLX3-H1141
ID	100020900
Measuring principle	Combination of gyroscopes and accelerometers
General data	
Measuring range	0...360 °
Number of measuring axes	1
Repeat accuracy	≤ 0.03 % of full scale
Linearity deviation	≤ 0.15 %
Temperature drift	≤ ± 0.006 %/K
Resolution	≤ 0.01 °
Electrical data	
Operating voltage	18...30 VDC
Residual ripple	≤ 10 % U _{ss}
Isolation test voltage	≤ 0.5 kV
Wire breakage/Reverse polarity protection	yes
Communication protocol	IO-Link
Current consumption	< 50 mA
IO-Link	
Communication mode	COM 3 (230.4 kBaud)
Minimum cycle time	1.3 ms
Function pin 4	IO-Link
Mechanical data	
Design	Rectangular, QR20
Dimensions	71.6 x 62.6 x 20 mm
Housing material	Plastic, Ultem
Electrical connection	Connector, M12 × 1

Features

- Rectangular, plastic, Ultem
- Status displayed via LED
- Angle detection via one axis with 360 ° measuring range
- Temperature detection from -40 °C to 85 °C
- High protection class IP68/IP69K
- Protected against salt spray and rapid temperature change
- 18...30 VDC
- M12 × 1 connector, 4-pin
- Communication via IO-Link

Wiring diagram

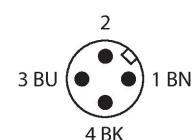
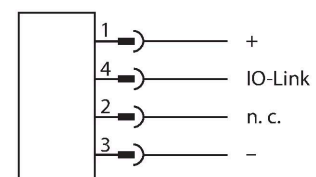

Functional principle

The dynamic inclinometers use an acceleration measuring cell and a gyroscope sensor to determine angles. Influences caused by vibrations or interfering acceleration are minimized by applying an intelligent fusion algorithm to the acceleration data and the rotation rate values. This enables the sensor to output a robust signal with impressive precision and speed, even in moving, dynamic applications.

Technical data

Environmental conditions	
Ambient temperature	-40...+85 °C
Temperature changes (EN60068-2-14)	-40... +85 °C; 20 cycles
Vibration resistance (EN 60068-2-6)	20 g; 5 h/axis; 3 axes
Shock resistance (EN 60068-2-27)	200 g; 4 ms ½ sine
Protection class	IP68 IP69K
MTTF	548 years acc. to SN 29500 (Ed. 99) 40 °C
Power-on indication	LED, Green
Measuring range display	LED, yellow

The measuring principle used makes mounting and commissioning the device easy. The robust sensors are positioned with the cast side on a flat surface so that the casting compound is covered. The sensor is then secured with two screws. The sensor can also record the temperature, which can be used to monitor the condition of the machine.

Mounting instructions

Mounting instructions/Description

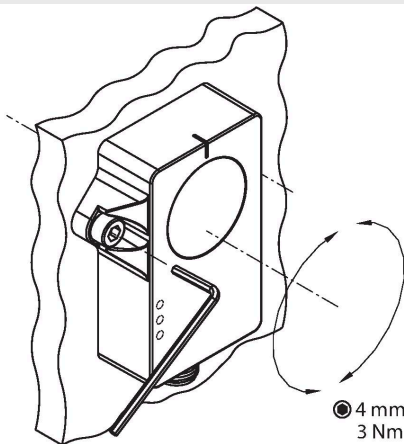

The measuring principle enables simple mounting and commissioning, for example because a metal environment does not interfere with the measuring principle. A green LED indicates whether the sensor is being supplied properly. The green flashing LED indicates that IO-Link communication is active. One yellow LED per inclination axis acts as a zero position indicator to aid commissioning. It is constantly illuminated when the position of the inclinometer is in a window of $\pm 0.5^\circ$ around the center point. The LED flashes with increasing frequency the more the sensor approaches the center point position.

Accessories

AP-Q20L60-QR20

100029224

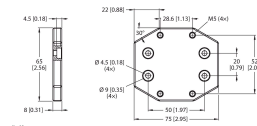

Adapter plate for mounting the QR20 housing with mounting holes for the Q20L60 housing

Accessories

Dimension drawing	Type	ID	
	RKC4T-2-RSC4T/TXL	6625604	Extension cable, M12 female connector, straight, 3-pin to M12 male connector, straight, 3-pin; cable length: 2 m, jacket material: PUR, black; cULus approval

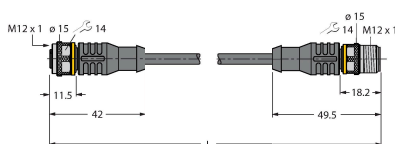

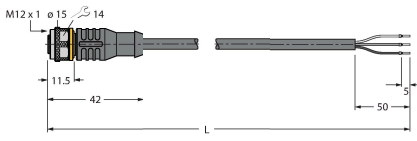
Dimension drawing	Type	ID	
	RKC4T-2/TXL	6625500	Connection cable, M12 female connector, straight, 3-pin, cable length: 2 m, jacket material: PUR, black; cULus approval